

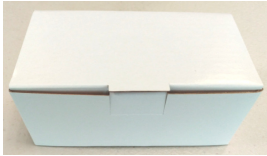

Bluetooth V4.2 BLE RS-232 Serial Adapter

Model: BLE-232C

1. Package content:

<p>BLE RS-232 adapter</p>  <p>White Box Dimension: 11 x 6 x 5 (cm) Total Package Weight: 105 g</p> 	<p>Package Contents:</p> <ul style="list-style-type: none"> ● BLE RS-232 adapter x 1 ● Screw x2, Screw nut x 2 ● A4 User manual x 1 ● Mini USB Cable x 1 
---	---

2. Profile:

2.1 Top view:

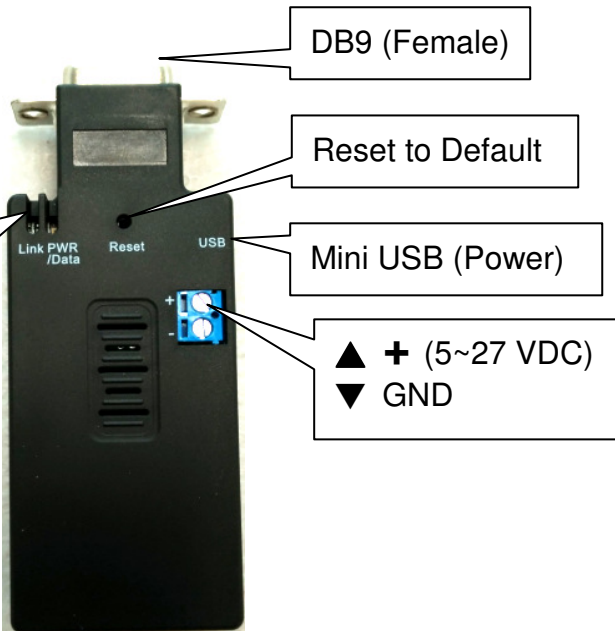

DB9 (Female)

Reset to Default

Mini USB (Power)

▲ + (5~27 VDC)
▼ GND

LED:
Link: Blue
PWR/Data: Red

LED Status	Description
Data LED flash	Data transmission
Data LED solid on	No data transmission
Link LED solid on	BLE Link
Link LED flash	No Link
Data & Link LED solid on	DFU/OTA Mode

2.2 DB9 connector:

There're 2 screws and 2 nuts inside the package, the screw or nut are available.

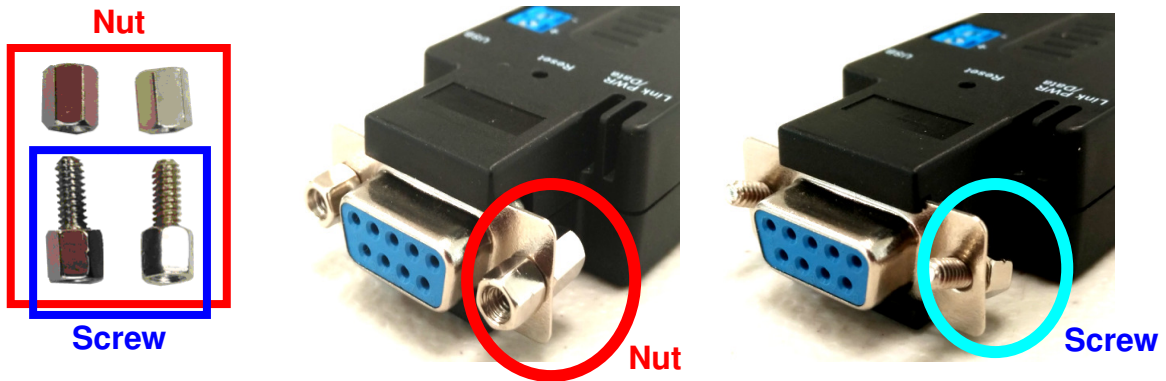

2.3 Rear Side:

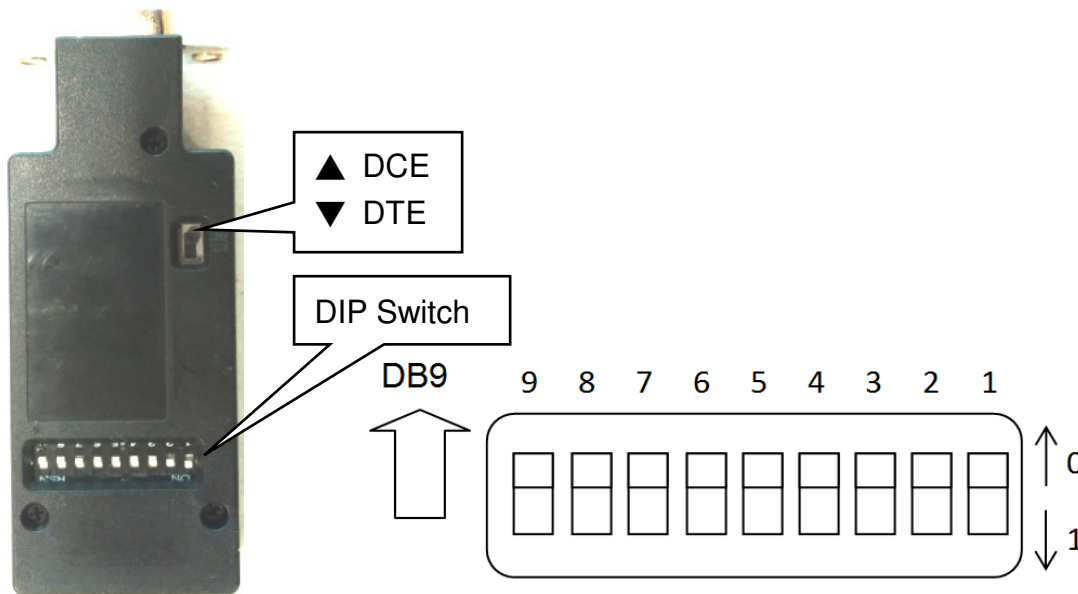

Switch configuration:

Setup	CTS/RTS	Stop Bit	Parity	Role	Baud Rate
9	8	7	6-5	4	3-2-1
0: Switch	0: Disable	0: 1	00: None	0:Slave	110:2400
1: Command	1: Enable	1: 2	01: Odd	1:Master	111:4800
			10: Odd		000:9600
			11: Even		001:19200
					010:38400
					011:57600
					100:115200
					101:230400

Remark:

1. 00000000 by default, in **red bold** character
2. The GATT service and AT command will support more settings than the DIP switch, please check the page 4 section 5 and page 5 section 6.

2.4 RS232 Interface (Female)

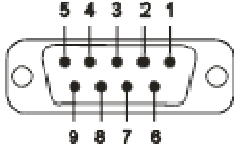

Pin	Signal	DTE Direction	DCE Direction	Description
1	N/A			
2	TxD	Output	Input	Transmitted data
3	RxD	Input	Output	Received data
4	N/A			
5	GND			Ground
6	N/A			
7	CTS	Input	Output	Clear to send
8	RTS	Output	Input	Request to send (Default)
9	VCC			Power Input (5~27 VDC)

3. Power supply:

3.1 Voltage: 5~27 VDC, **Don't exceed the limit.**

3.2 There're 3 ways to power the adapter: Mini USB, Terminal Block and pin9 of DB9, please choose one. **Don't power the adapter by more than two sources.**

3.3 The mini USB cable is inside the standard package.

4. Specifications:

4.1 Default value:

- Baud rate: 9,600 bps
- Data bit: 8
- Parity: none
- Stop bit: 1
- Flow control: none
- Device Name: BLE 232
- 4.2 All function of COM port:
- Baud Rate: 1.2/2.4/4.8/9.6/19.2/38.4/57.6/115.2/230.4/460.8/921.6 Kbps
- Parity: none/even/odd
- Stop bit: 1/1.5/2
- Data bit: 7/8

Remark: The GATT service and AT command will support all the functions, please check the page 4 section 5 and page 5 section 6.

4.3 Range: max. 50 m in open space

4.4 TX Power: Max. 3 dBm

4.5 RX Sensitivity: -89 dBm typical

4.6 TX current consumption of 15.6 mA (radio only, 0 dbm)

4.7 Operation Temperature: -40 °C to +70 °C

4.8 Dimensions: 81.6 mm (L) x 31.75 mm (W) x 17 mm (H)

4.9 Antenna Gain: max. 2 dB

Remark: All contents are subject to change without notice.

5. GATT Service:

5.1 Architecture:

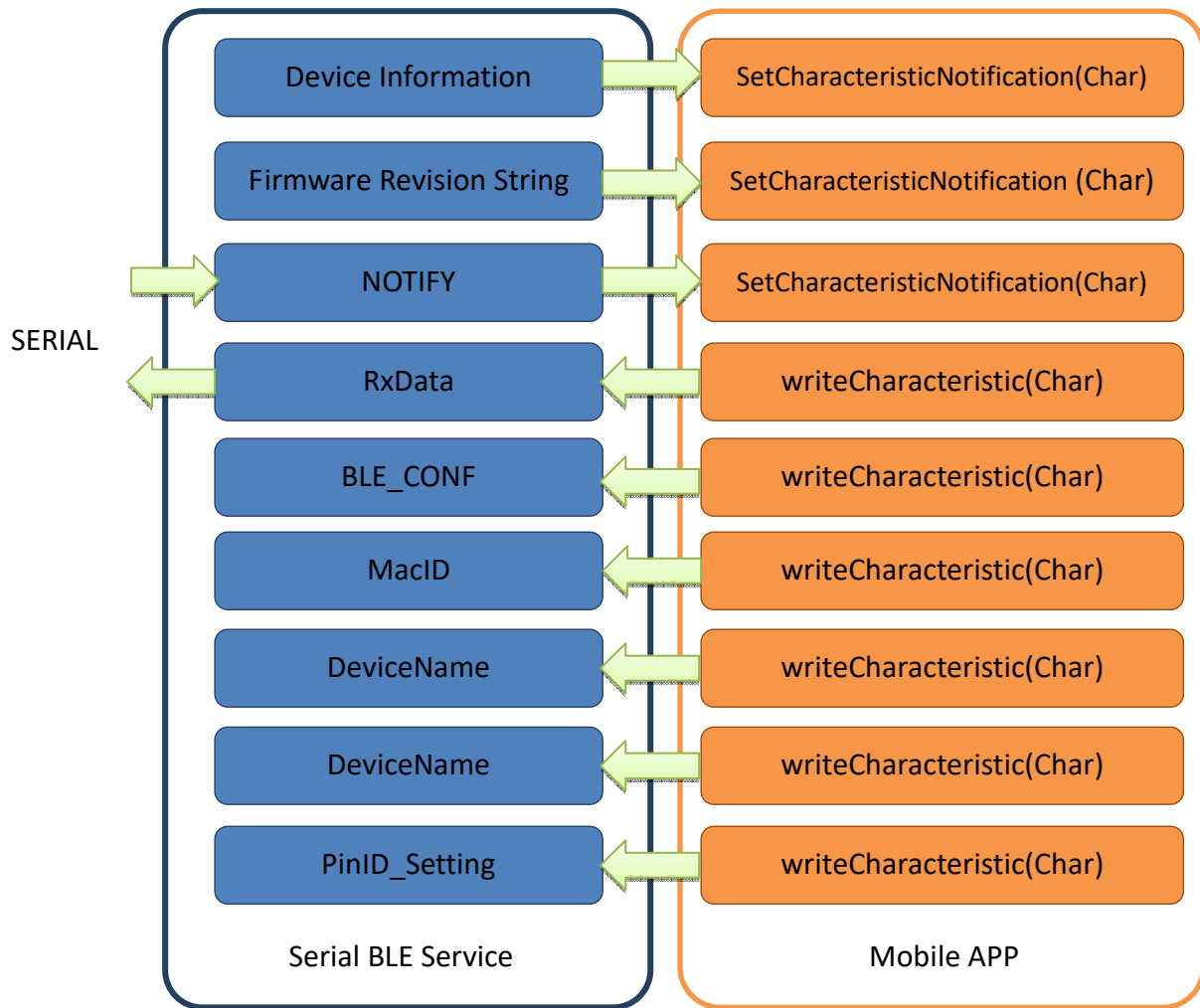

5.2 Programming Interfaces:

GATT	UUID
UUID_Device Information	0000180A-0000-1000-8000-00805F9B34FB
UUID_Firmware Revision String	00002A26-0000-1000-8000-00805F9B34FB
UUID_NOTIFY (~20 bytes)	00031234-0000-1000-8000-00805F9B0130
UUID_RxData (~20 bytes)	00031234-0000-1000-8000-00805F9B0131
UUID_MacID (6 bytes)	00031234-0000-1000-8000-00805F9B0133
UUID_DeviceName (15 bytes)	00031234-0000-1000-8000-00805F9B0134
UUID_Reboot (1 bytes)	00031234-0000-1000-8000-00805F9B0135
UUID_PinID_Setting (6 bytes)	00031234-0000-1000-8000-00805F9B0136

UUID_BLE_CONF (7 bytes)		00031234-0000-1000-8000-00805F9B0132	
Byte0	Byte1	Byte2	Byte3
Data bit	Hwfc	Stop Bit	Parity Bit
7,8	0x01:on 0x00:off	2:1 3:1.5 4:2	0x02 : No Parity 0x01 : Odd Parity 0x00 : Even Parity
Byte4	Byte5	Byte6	
Baud Rate	Device Mode	Reset To Default	
00:9600 01:19200 02:38400 03:57600 04:115200 05:230400 06:2400 07:4800 08:1200 09 : 460800 10 : 921600	0x01:on 0x00:off	0x01: Reset	

6. Command set via COM port:

Command	Value	Description
AT		Check the connection status between control terminal and the RS-232 adapter. Response: "OK" when the connection is ok. Response: "ERROR" when the connection is not ok.
AT		Test the RS-232 status when first connect the adapter with the controller.
(Default)	N	The command will disable the auto link function.
	?	Inquire the current setting.
BAUD=		This command is used to specify the baud rate of COM port. The command will need 200 ms delay.
	1200	1200 bps
	2400	2400 bps
	4800	4800 bps
	9600	9600 bps
(Default)	19200	19200 bps
	38400	38400 bps
	57600	57600 bps
	115200	115200 bps
	230400	230400 bps
	460800	460800 bps

	921600	921600 bps
	?	Inquire the current baud rate.
BIT=		
	7	7 data bit
	8	8 data bit
	?	Inquire the current data bit
DEFAULT=		This command is used to restore the default settings and originate a warm start.
	Y	Restore the default settings (e.g. 19200 bps). The command will re-start the system for 1 second.
DFU=		Device Firmware Upgrade via PC software. OTA (Over the air) is available to upgrade the firmware by APP
	Y	
ECHO=		This command is used to specify whether the adaptor echoes characters received from the UART back to the DTE/DCE.
	N	Command characters received from the UART are not echoed back to the DTE/DCE.
(Default)	Y	Command characters received from the UART are echoed back to the DTE/DCE.
	?	Inquire the current setting.
FLOW=		This command enable or disable flow control signals (CTS/RTS) of the UART port. Note, the setting is not affected by DEFAULT. The command will need 1 second delay.
(Default)	N	Disable flow control.
	Y	Enable flow control.
	?	Inquire the current setting
NAME=		This command is used to specify a device name for the adaptor. You can specify a friendly name using 0 to 9, A to Z, a to z, space and -, which are all valid characters. Note that "first space or -, last space or - isn't permitted". The default name is "Serial Adaptor".
(Default)	BLE232	Default device name
	xx....xx	"xx....xx" is a character string with the length from 2 to 30.
	R	Restore the default settings name="BLE Serial".
	?	Inquire the name of the local adaptor.
PARITY=		This command is used to specify parity bit setting of COM port. The command will need 200 ms delay.
(Default)	N	None parity bit
	O	Odd parity
	E	Even parity
	?	Inquire the current setting.
PIN=		This command is used to specify a PIN code. The default PIN is "123456". Paired adaptors should have a same PIN. This command is used to specify a PIN. The default PIN is "1234" and the length is not smaller than 4. Paired adaptors should have a same PIN. The PIN code includes the numeral and English characters.
(Default)	123456	
	xx....xx	"xx....xx" is a 6 digit string or English character (in capital or lower case)

	N	Cancel authentication by PIN.
	R	Restore the default settings PIN="123456".
	?	Inquire the current PIN.
PROMPT=		The command is used to decide whether result messages are prompted when Setup commands are executed. The result messages are: OK/ERROR for command execution.
(Default)	Y	Prompt result messages.
	N	Not prompt result messages.
	?	Inquire the current setting.
ROLE=		This command is used to specify whether the adaptor is in the central or peripheral role. If the device role is changed, the adaptor will reboot and all paired addresses will be cleared.
	C	Set the adaptor to the central role.
(Default)	P	Set the adaptor to the peripheral role.
	?	Inquire the current role of the adaptor.
STATUS=		Inquire all the current setting of the adapter.
	T	Inquire the inner temperature of the IC in centigrade
	?	Display the current setting of the adapter
STOP=		This command is used to specify one or two stop bits of COM port. The command will need 200ms delay.
(Default)	1	One stop bit.
	2	Two stop bits.
	?	Inquire the current setting.
VERSION=		This command is used to inquiry the firmware version.
	?	Inquire the version codes.

7. Central and Peripheral: (Similar like the Master and Slave roles)

7.1 DIP switch setting: The central will pair the slave automatically, please refer to page 2 section 2.3.

- Switch DIP-9 to 0 (Switch)
- Switch DIP-4 to 1 (Master)
- The central will link with the neighboring peripheral automatically. The blue LED will be solid on. The central will link with the paired peripheral on next time when power on.
- Please reset to the default and follow the above procedures if you want to link with other BLE devices.

7.2 AT command: Please refer to page 5 section 6.

- Set "role=c" or "ROLE=C" in one adapter.
- The central will link with the neighboring peripheral automatically. The blue LED will be solid on. The central will link with the paired peripheral on next time when power on.
- Please reset to the default and follow the above procedures if you want to link with other BLE devices.

7.3 APP setup: Please contact the supplier to for the test APP.

- The APP will search the BLE and select one as the central.
- Then select the other one as the peripheral and link.
- The central will link with the neighboring peripheral automatically. The blue LED will be solid on. The central will link with the paired peripheral on next time when power on.
- Please reset to the default and follow the above procedures if you want to link with other BLE devices.

8. APP: The APP is used for the configuration and the data transmission test.

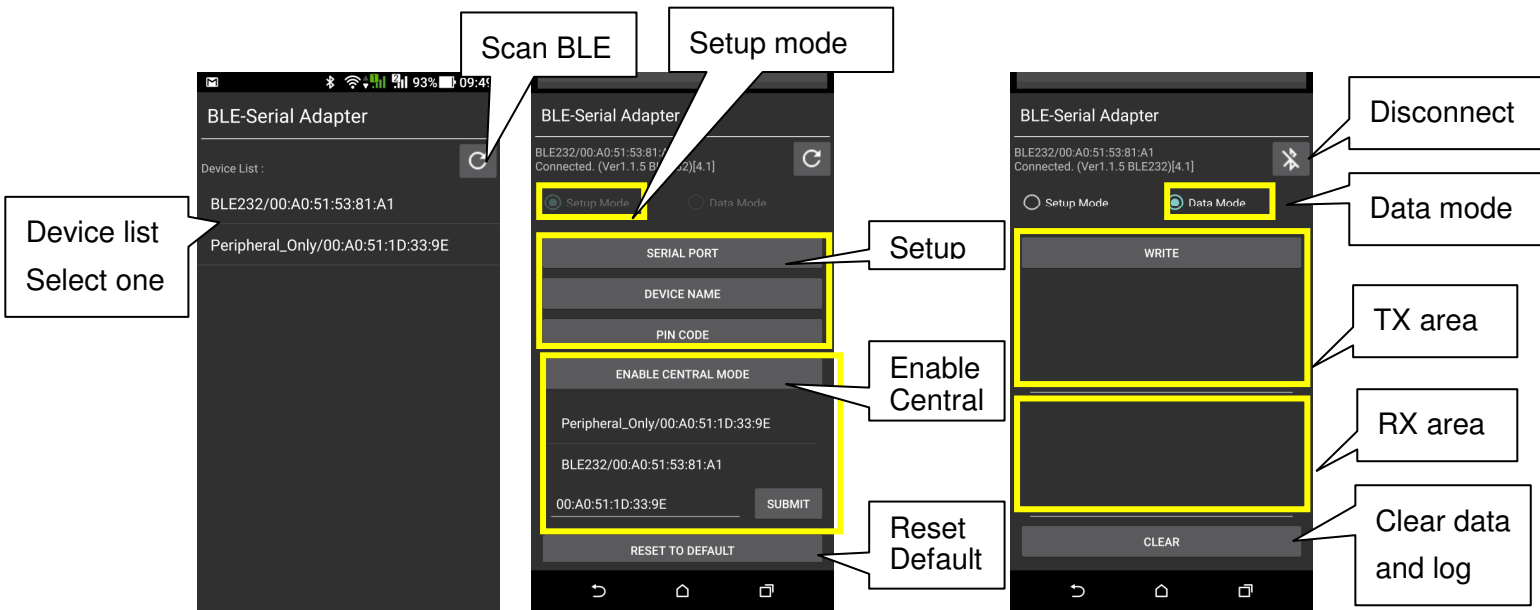

Scan and select one.

Connect and configure

Data transmission test.

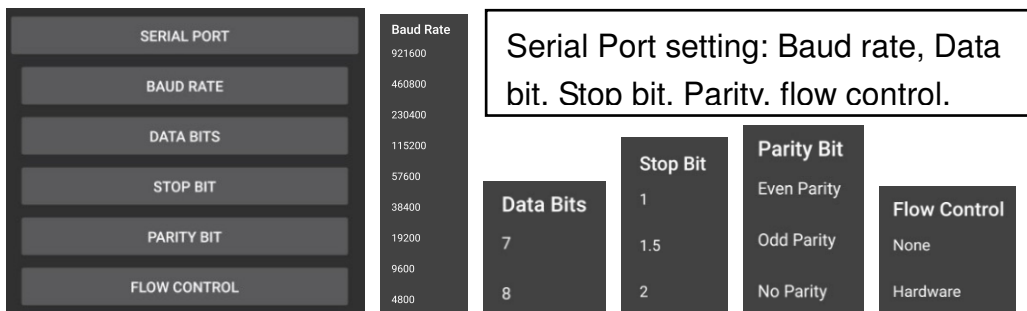

Download:

Android:



iOS:



Remark: Please contact the supplier for the APP download or the sample code.